

Sui as Infrastructure

For Rollups & Sidechains

Lisbon Research Offsite

What People Try to Do

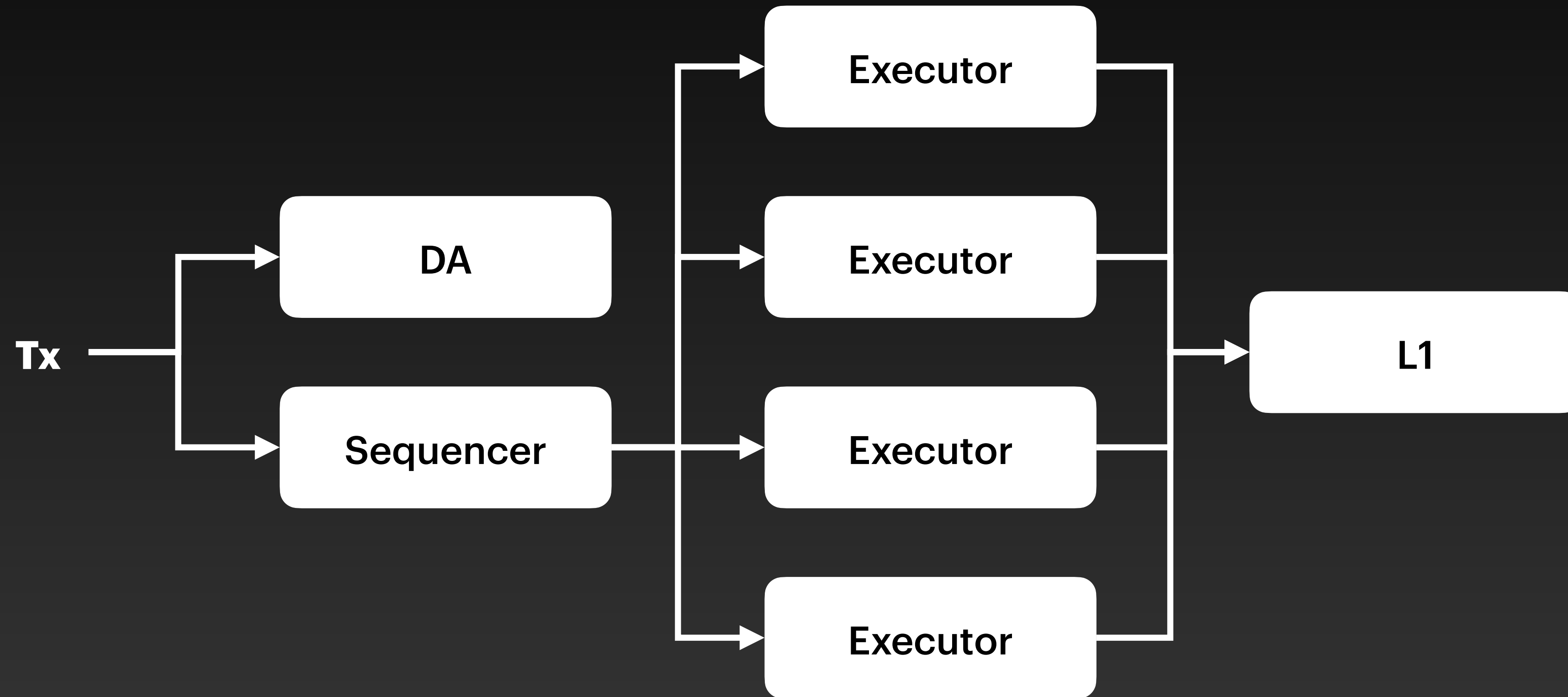

What People Try to Do

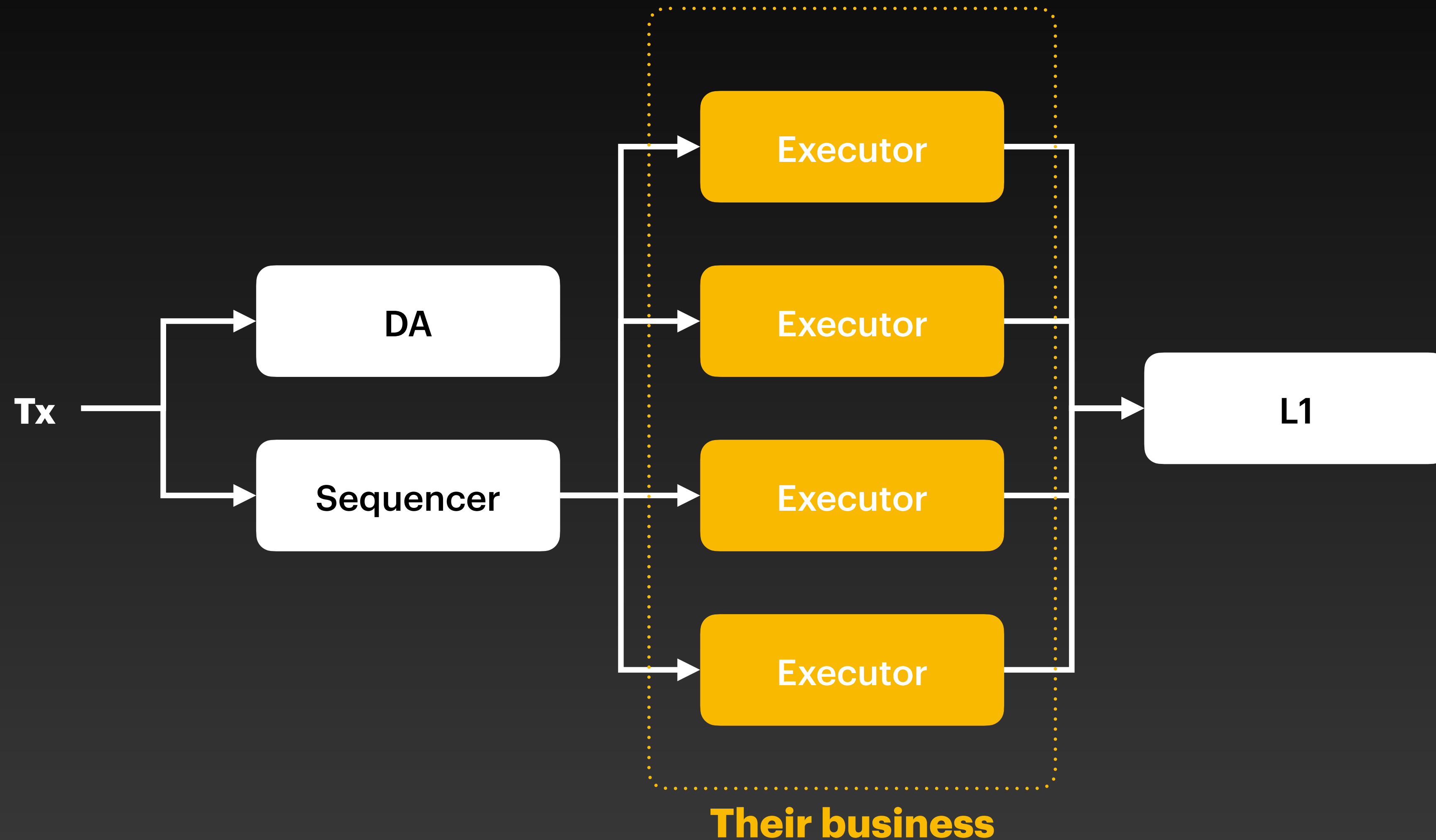

What People Try to Do

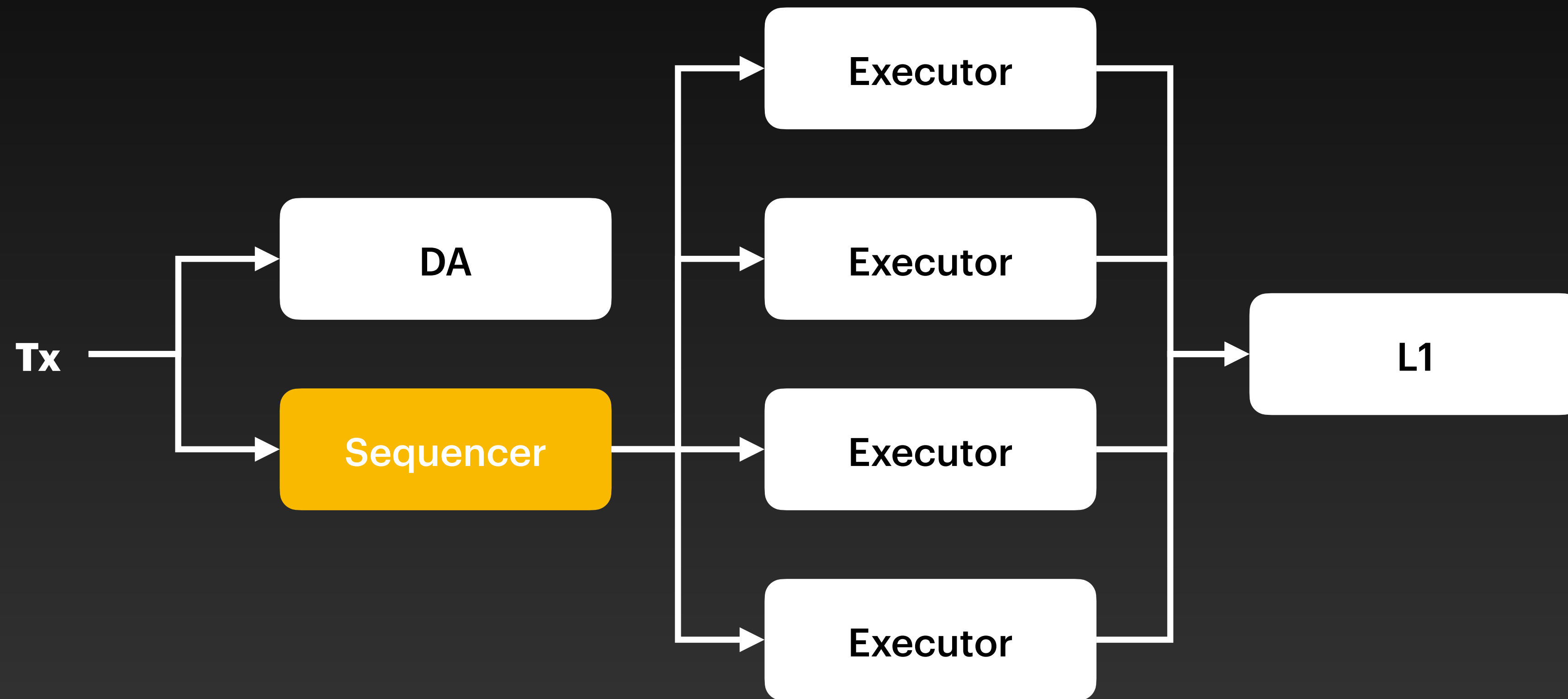

The Sequencer Problem

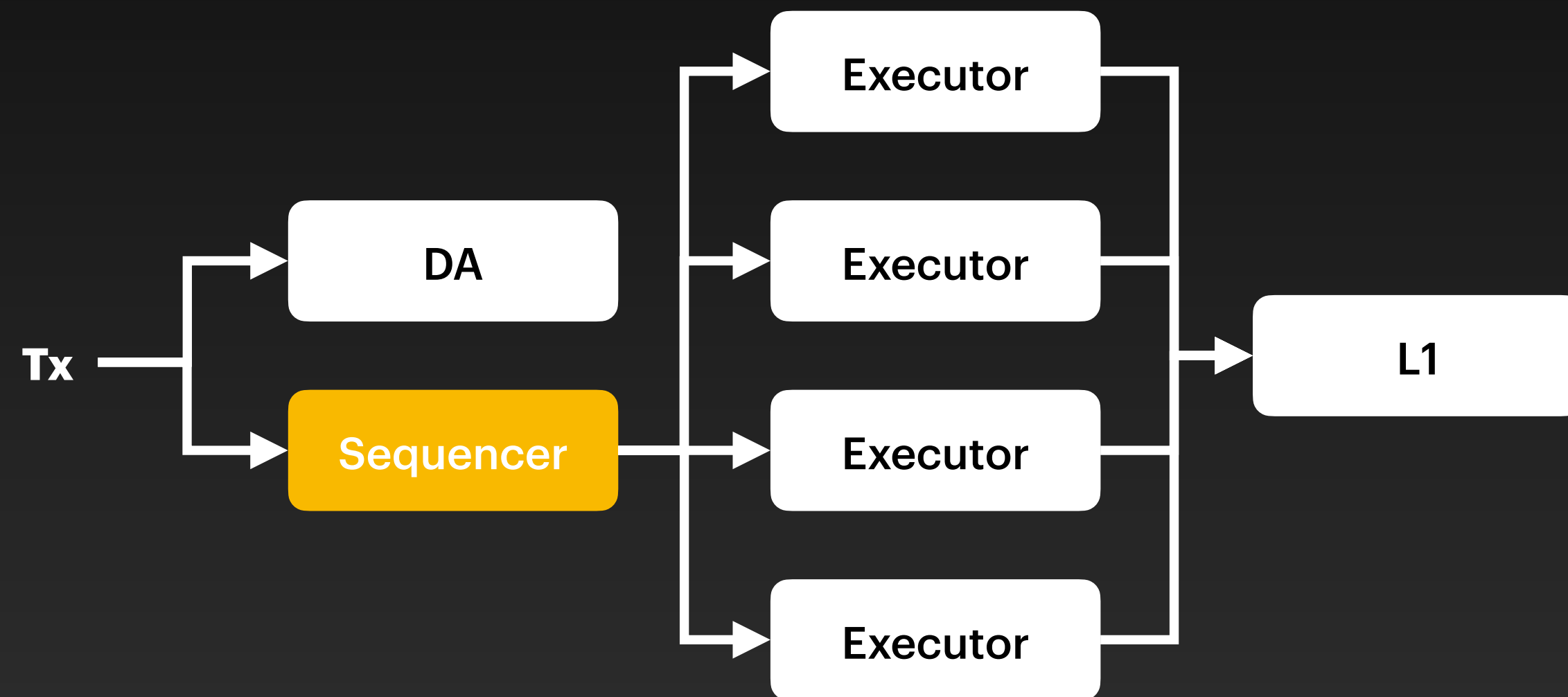

- **Centralised sequencer**

The Sequencer Problem

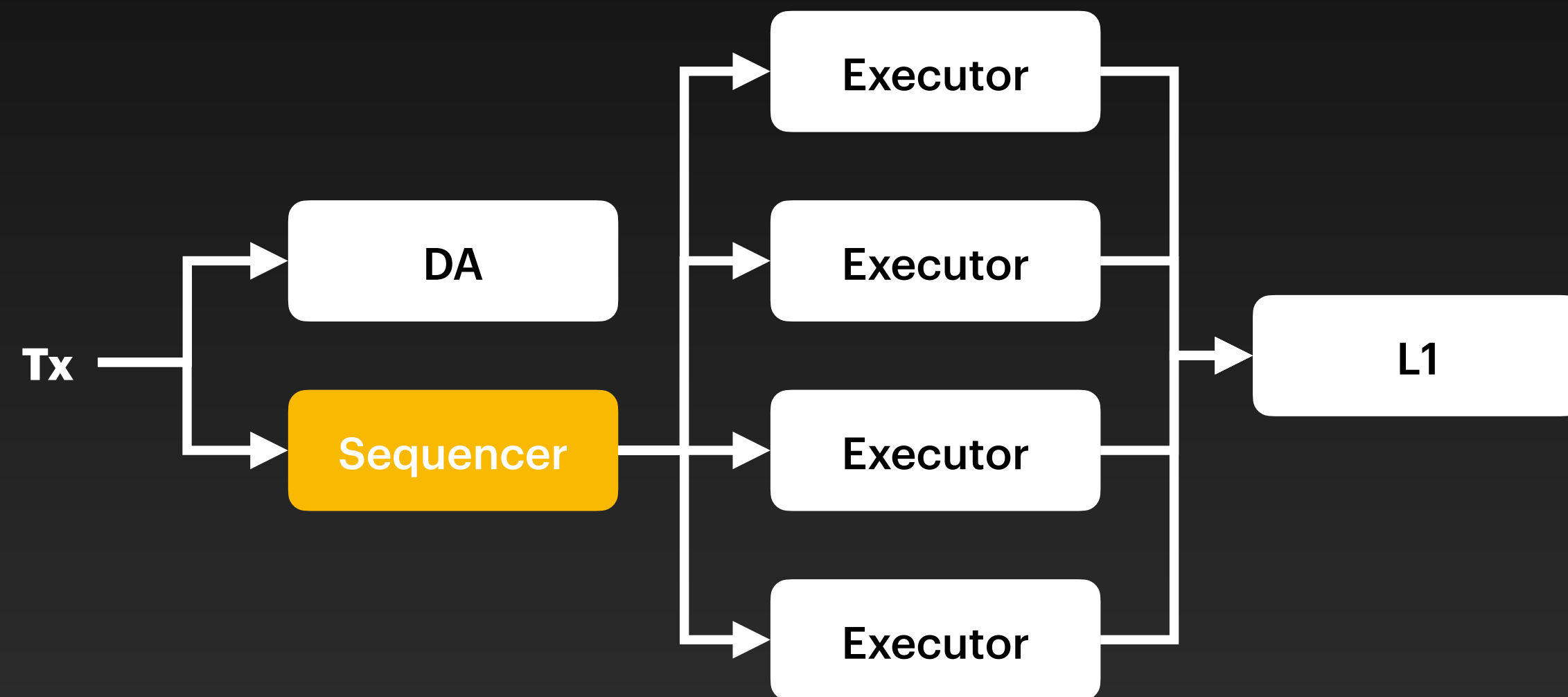

- **Centralised sequencer**
- **Can I use Bullshark**

The Sequencer Problem

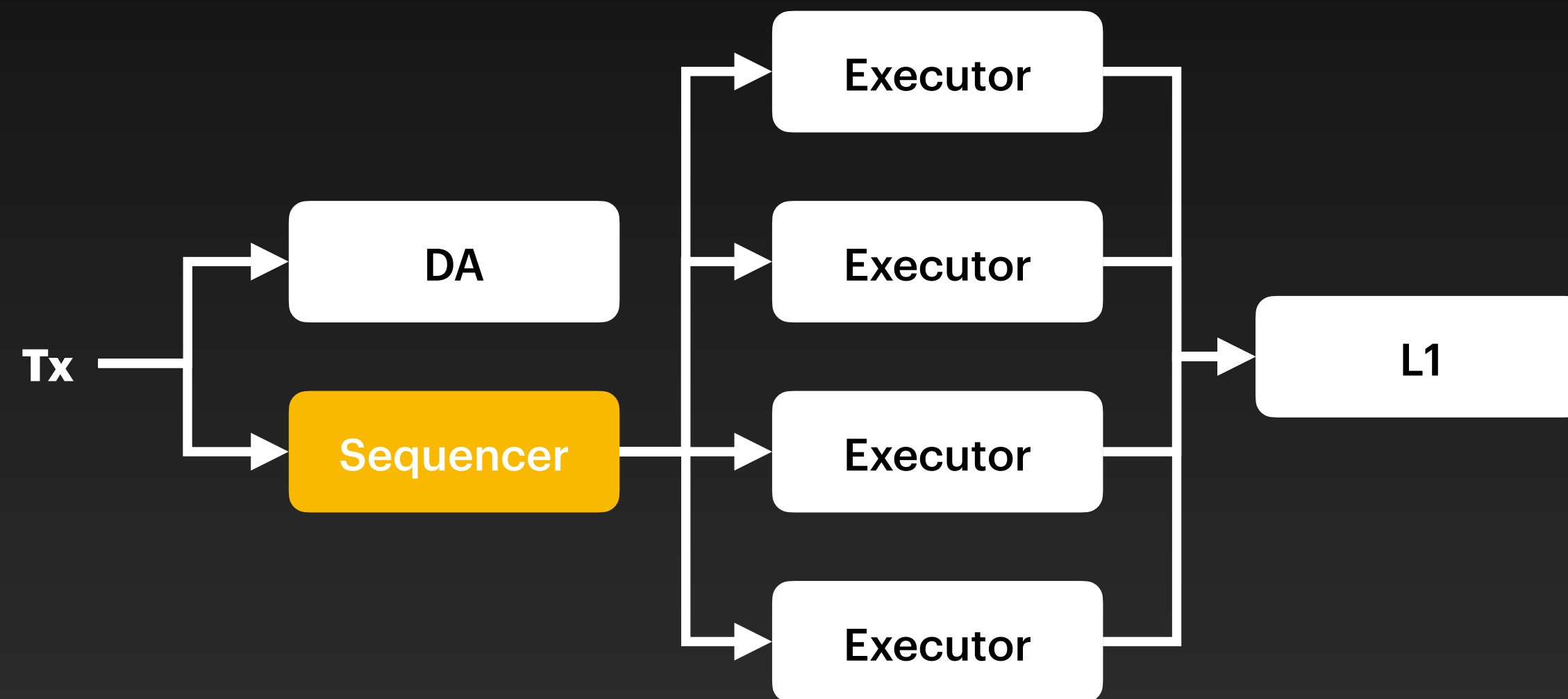

- **Centralised sequencer**
- **Can I use Bullshark**
- **Can I use Mysticeti**

The Sequencer Problem

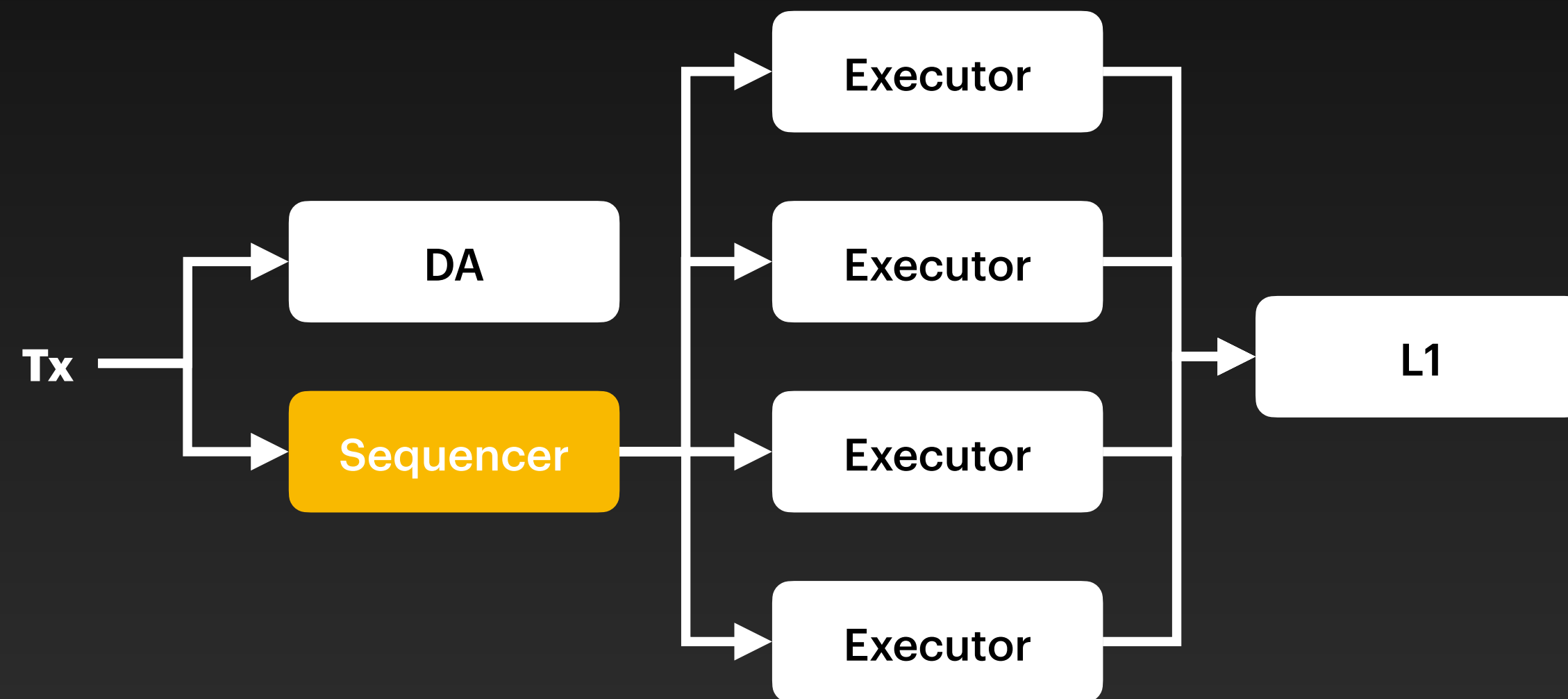

- **Centralised sequencer**
- **Can I use Bullshark**
- **Can I use Mysticeti**
- **I am going to use Tendermint**

The Sequencer Problem

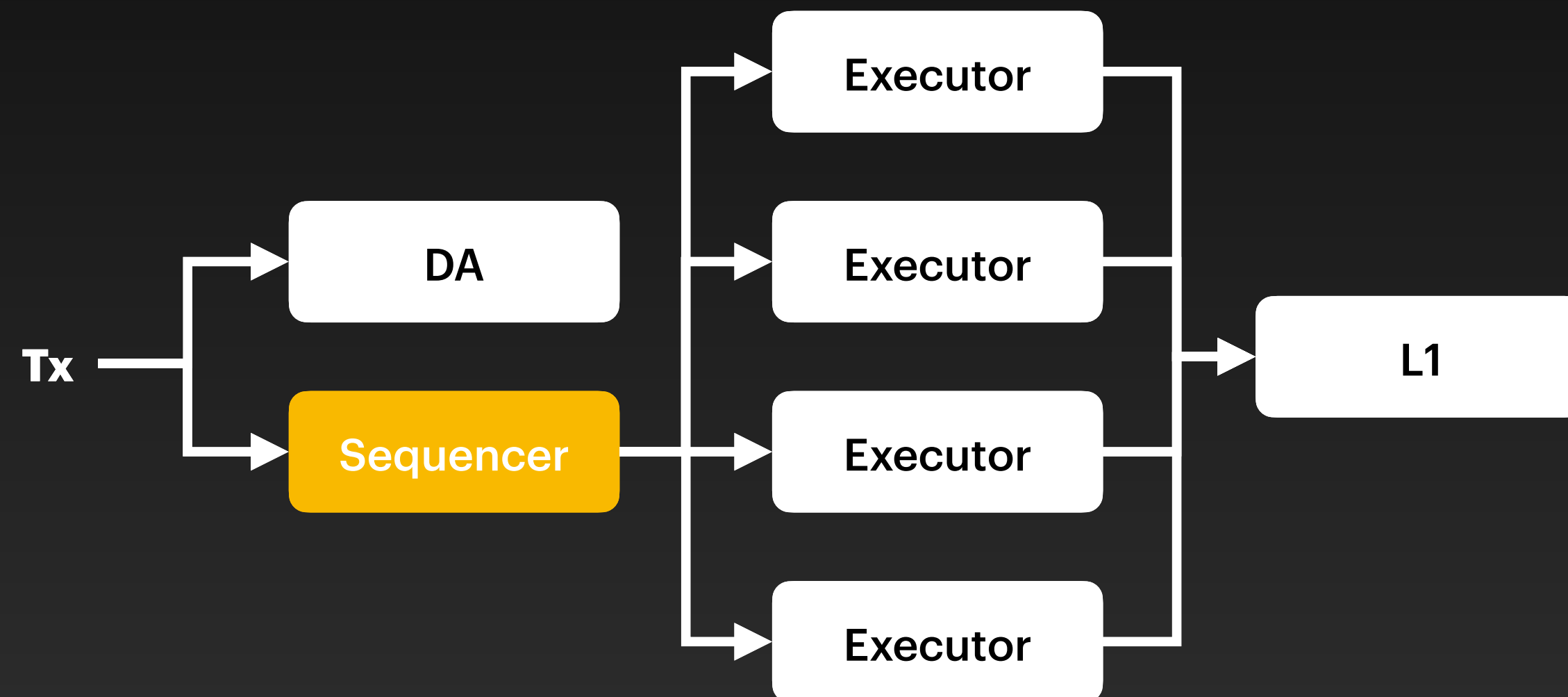

- **Centralised sequencer**
- **Can I use Bullshark**
- **Can I use Mysticeti**
- **I am going to use Tendermint**
- **How much to hire you?**

Sui as a Sequencer

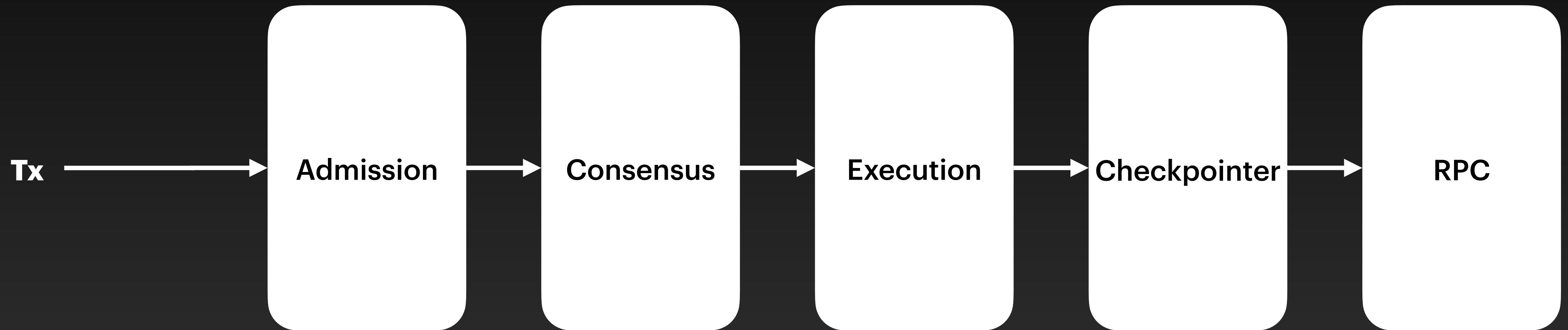

Sui as a Sequencer

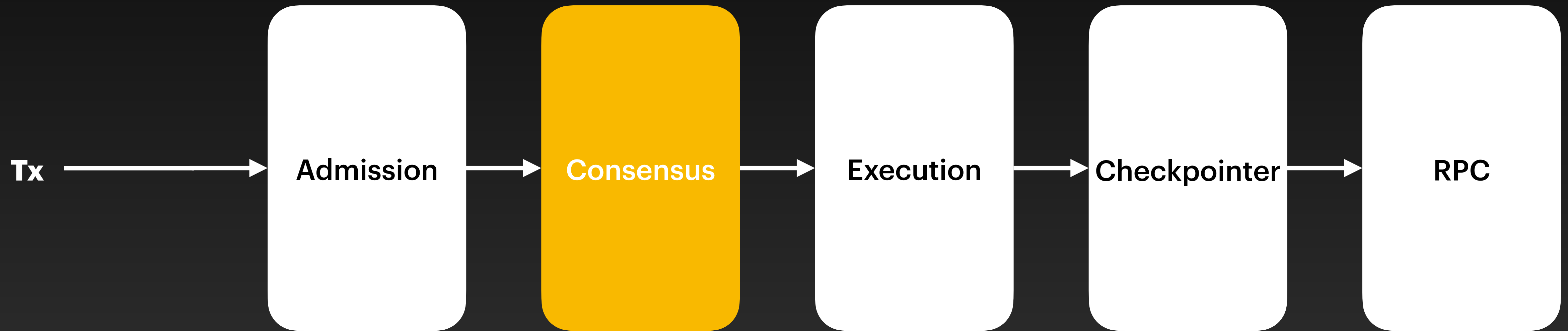

Proposed Architecture

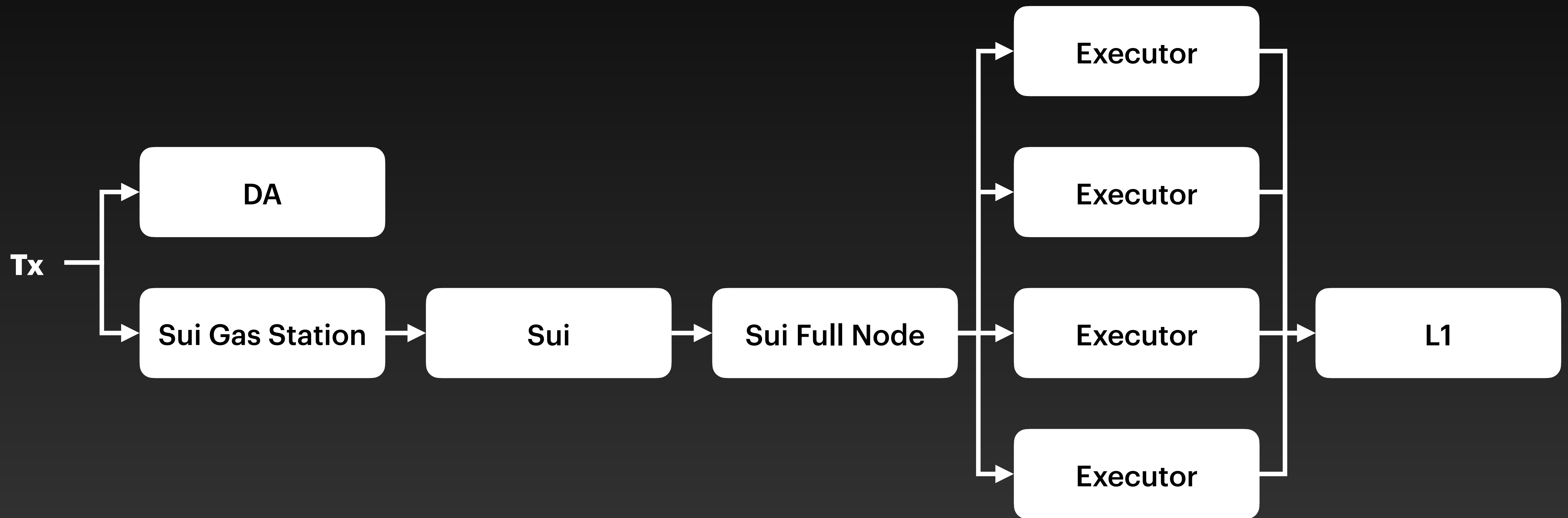

Proposed Architecture

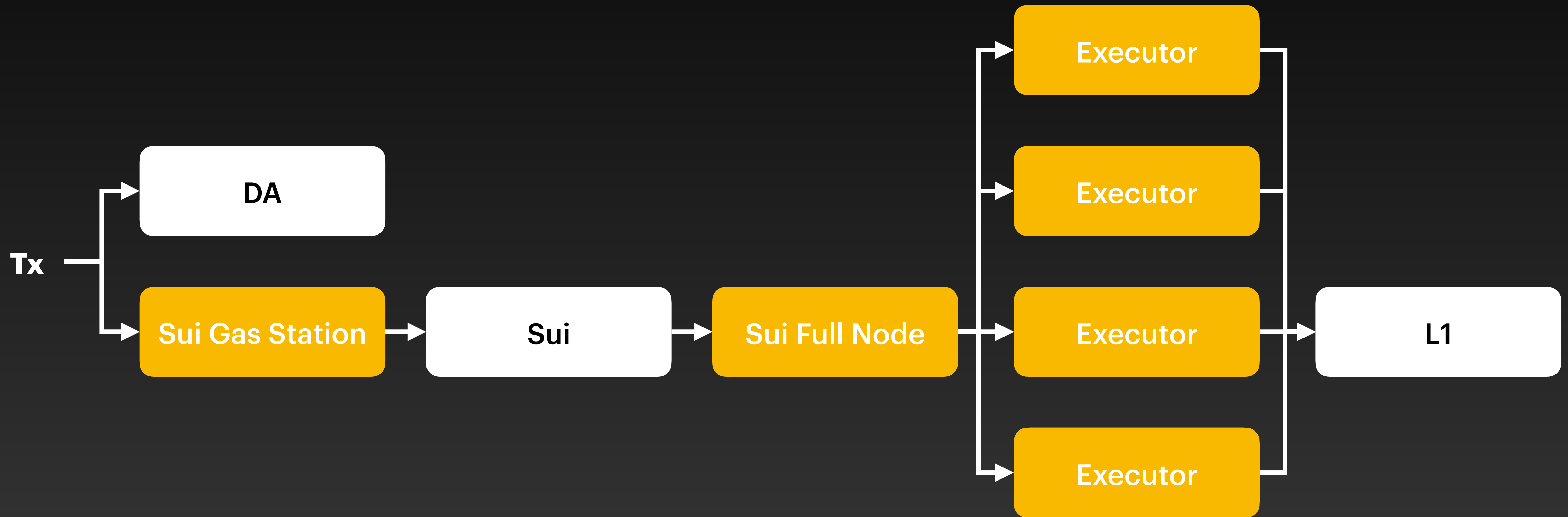

Not Trusting Sui

- **The L1 is responsible for Safety & Liveness (escape hatch)**
- **The DA is responsible for data availability**
- **Sui is responsible for performance**
 - **(Special transaction on the L1 can replace Sui by Solana)**

Zero Changes to Sui

(Can happen today)

Improvements (1)

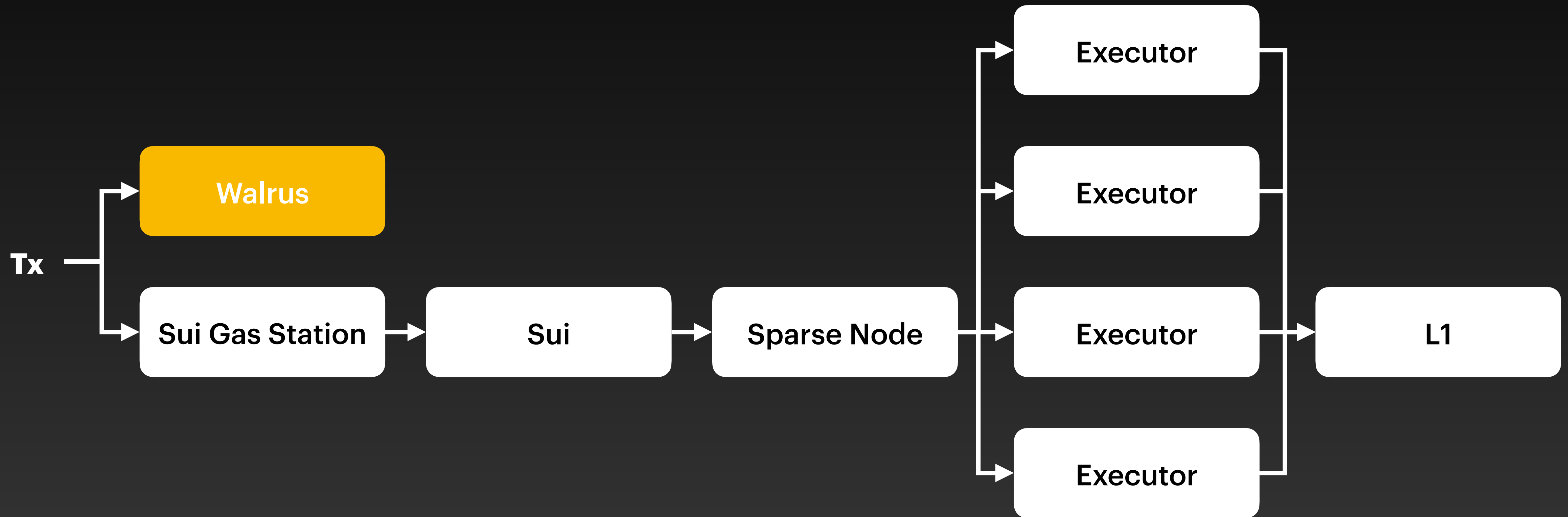

Improvements (2)

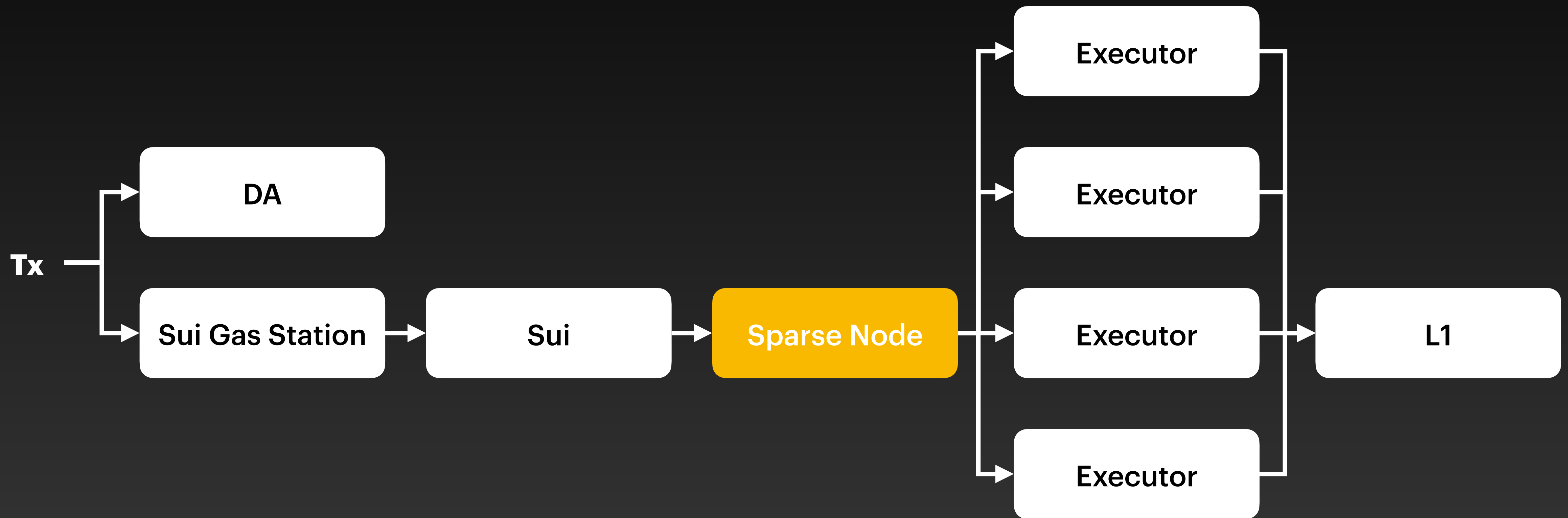

Improvements (3)

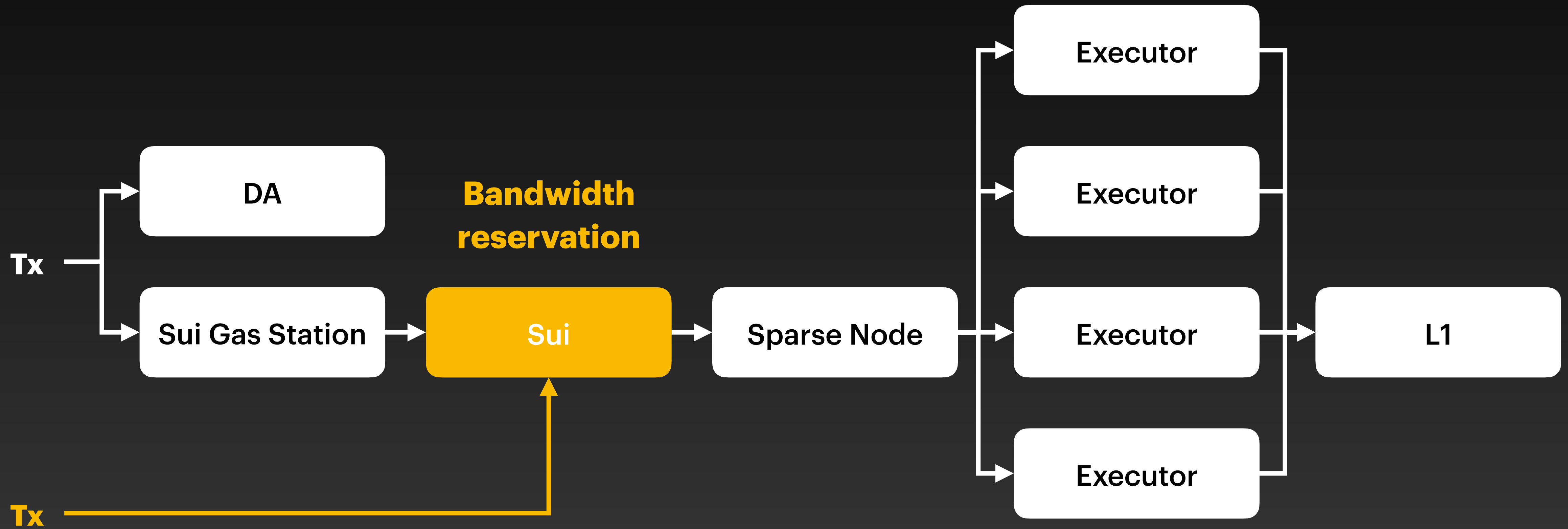

Discussion

- **Why yes?**
 - **Showcase the power of Sui ecosystem**
 - **Make people realize what they are missing**
 - **Probably no pushback as we “donate” to other ecosystems**
- **Why no?**
 - **We literally donate our tech to other ecosystems**
 - **Value capture happens at the L1 and at the Executor/L2**
 - **We get peanuts to persist a few MB for a month + order DA proofs**

EVM Sidechain on Sui

Lisbon Research Offsite

SideChain with Sui Sequence



Issues for EVM

- **Sui can't validate transactions**
 - **EL crashes if an invalid transaction is scheduled for execution**

EVM SideChain with Sui Sequence

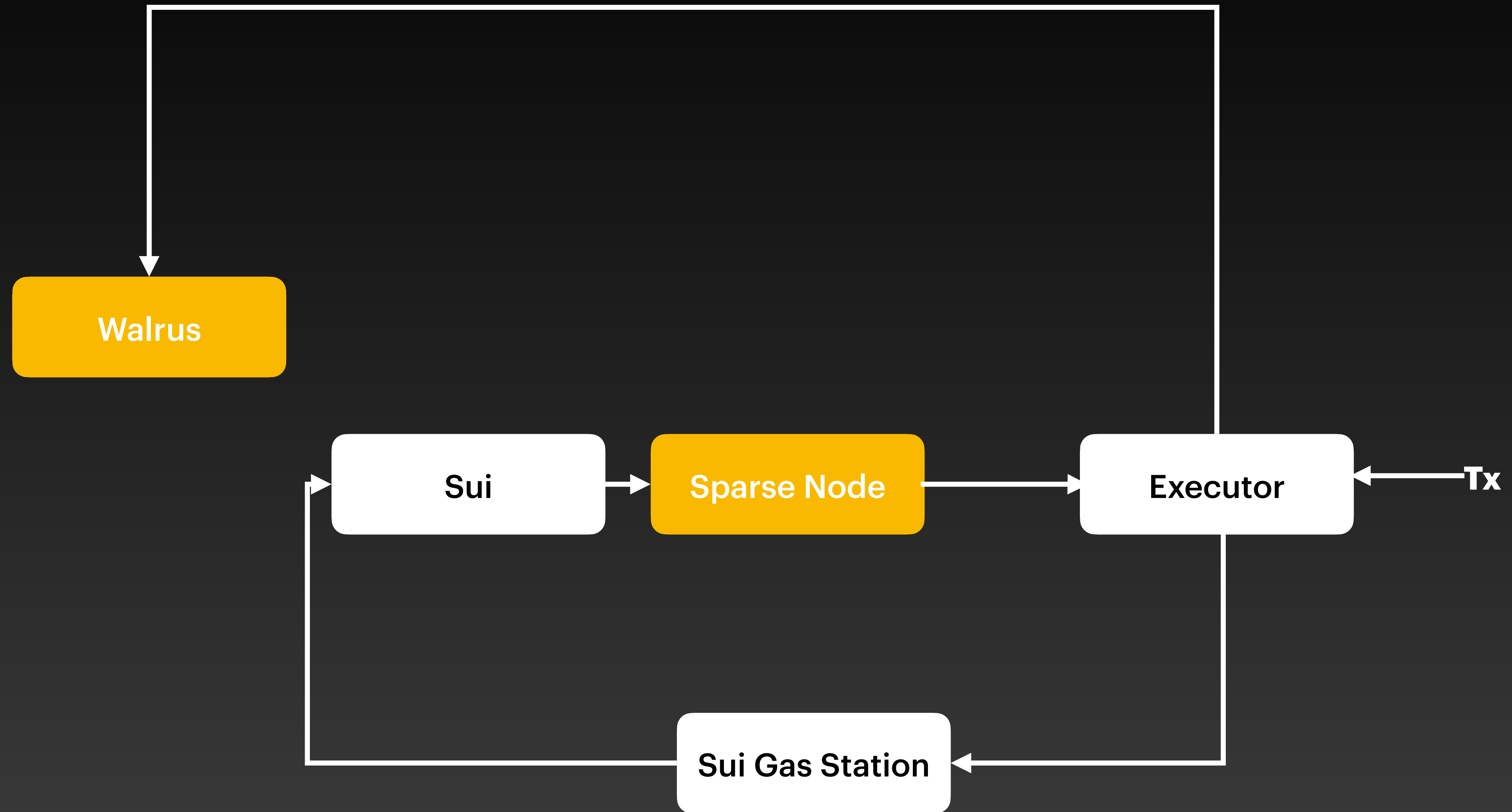

Issues

- **If there is a proposer it might crash**
- **If there is a single proposer it might censor**

EVM SideChain with Sui Sequence

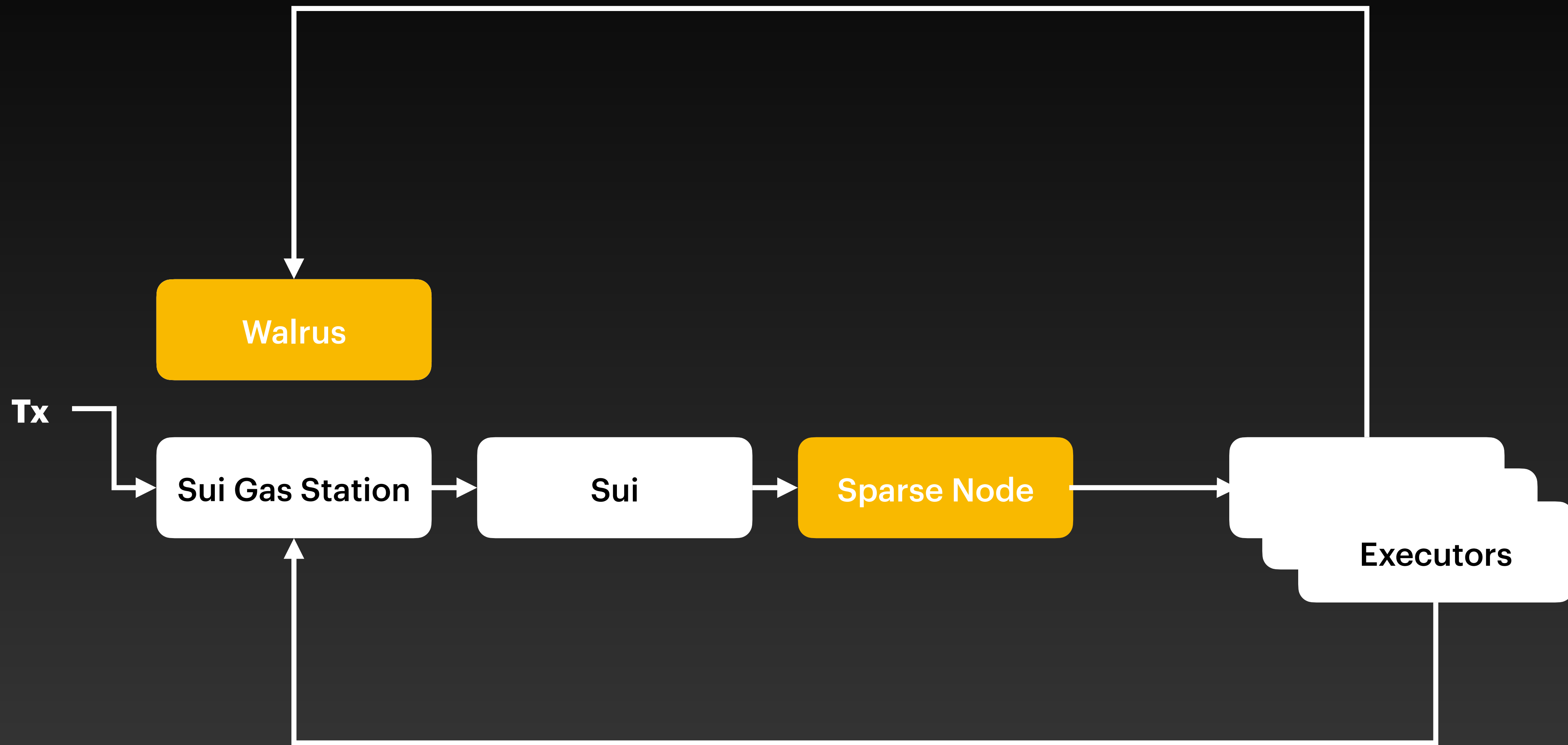

Discussion

- **Why yes?**
 - **Showcase the power of Sui ecosystem**
 - **Value capture happens through Sui only**
 - **We can built and run the EVM side-chain and also capture the rest of the value**
 - **Mysten-Fast and Mysten-Cheap Ethereum competitor**
 - **Bring your smart-contract's in the Sui Ecosystem**
 - **We can create special EVM addressed controlled via Move on Sui**
- **Why no? Do we even care?**
 - **Neither Ethereum or the other L2s will like it**